

AVR2000VA

NCTS Automatic Voltage Regulator

AVR2000VA

Product Features

- Autonomous voltage control to a given set point
- CPU controlled
- Meter LED Display (Input/Output)
- Status Indicator LEDs
- Precise protection of over voltage and below voltage
- Precise delay time, able to choose long delay time or short delay time
- Input range switch available
- Large AC range of Input Voltage
- USB port
- Simple and fast installation



System Connections

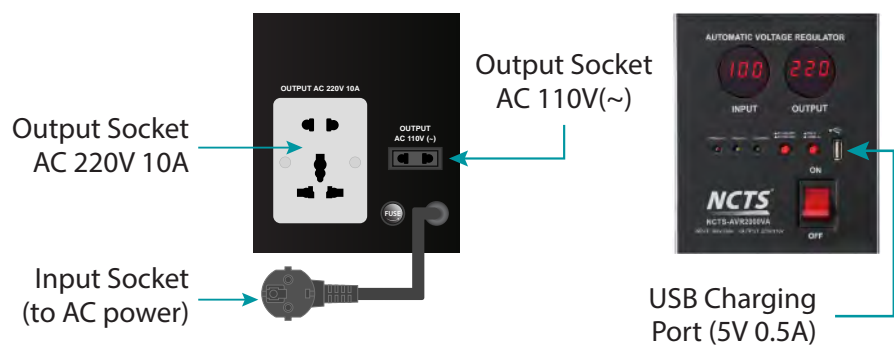

AVR2000VA

NCTS Automatic Voltage Regulator

Technical Specifications

Model: NCTS-AVR2000VA

Line Mode Specifications

Rated power (Input 190V)	1600W
Actual range of input volotage	100~260V (5 relays)
Frenquency	50Hz/60Hz
Output voltage	220V / 110V±10%
Rated output current	7A
Transformer	EI square aluminum transformer
Colour	Black + Silver
Delay time	3S/180S
Protection	High voltage/ Low voltage protection
Operating temperature	0~40°C
Relative humidity	10%RH~90%RH
Dimensions (mm)	640*315*210mm
Weight (kg)	26
Outer package (pcs/box)	4

Attention: only 60% power when input is 160V, 80% power when input is 190V

Dimensions

